

PARAMOUNT®

SIGNATURE CUT SHINGLES

Directions For Application

1 General Instructions

NOTICE: THESE SHINGLES MUST BE APPLIED TO CONFORM WITH ALL APPLICABLE BUILDING CODES. THESE DIRECTIONS REPRESENT COMMON AND ACCEPTED ROOFING PRACTICES. DEVIATIONS FROM THESE DIRECTIONS MAY ADVERSELY AFFECT WARRANTY COVERAGE, THE ASSEMBLED ROOF SYSTEM PERFORMANCE, ROOF APPEARANCE, COMPLIANCE TO PRODUCT STANDARDS, COMPLIANCE TO CODES, AND STATED ROOF AREA COVERAGE. See the PABCO® Limited Shingle Warranty for details, limits, and conditions. Ask your supplier for a copy or visit our web site at www.pabcoroofing.com.

Apply shingles exposing the bottom 4-1/2" to the weather. The step-by-step application instructions below apply to standard slope/inclines between 4" per foot and 21" per foot. For low slopes (between 2" and 4" per foot) and steep slopes (more than 21" per foot), modify the installation as described in Section 8. Do not apply these shingles on roofs having a slope less than 2" per foot.

IMPORTANT: FROM COURSE TO COURSE UP THE DECK, SHINGLE END JOINTS MUST BE MAINTAINED WITH A HORIZONTAL OFFSET OF 5-3/4". THE INSTALLER MUST ASSURE THAT ALL END JOINTS ARE COVERED. UNCOVERED END JOINTS MAY RESULT IN LEAKS WHICH ARE NOT COVERED BY THE PABCO LIMITED SHINGLE WARRANTY.

Ventilation: To prevent harmful condensation, air must circulate freely under the roof deck with air flow in all areas. A minimum of 1 ft² of total net free ventilating area is required for each 150 ft² of attic floor area. 1 ft² for each 300 ft² of attic floor area may be allowed if at least 40 percent and not more than 50 percent of the required ventilating area is provided by exhaust vents located in the uppermost portion of the attic or rafter spaces and a vapor barrier is present on the warm side of the insulation.

2 Roof Deck Requirements: All Construction

The minimum deck thickness must be either 3/8" plywood or 7/16" OSB type sheathing, conforming to the specifications of the APA - The Engineered Wood Association and the building code. As an alternative, the deck may be well-seasoned wood boards 1" minimum nominal thickness, 6" maximum width, spaced no greater than 1/8" apart. The deck must be sound and provide good anchorage for nails.

THESE SHINGLES SHOULD NEVER BE APPLIED TO ANY OTHER DECK without first obtaining written approval from PABCO® Roofing Products. Requests for approval must be accompanied by the deck manufacturer's recommended application procedure for asphalt shingles. APPLICATION DIRECTLY OVER POLYURETHANE OR POLYSTYRENE SURFACES WILL NOT BE APPROVED.

3 Underlayment

On decks with a pitch of 4" per foot or greater, for new construction or when old roofing has been removed, apply a single layer of breathable underlayment or asphalt saturated felt underlayment. Asphalt saturated felt must comply with ASTM D226, D4869, or D6757, or equivalent and the building code. The underlayment is installed to extend 1/4" to 3/8" beyond the drip edge at the eaves. Overlap underlayment layers with a 2" top lap, 4" end laps, or as directed by the underlayment manufacturer, and a minimum of 6" over both sides of all hips, ridges, and valleys. See Section 8 for application on slopes between 2" and 4" per foot.

Drip edges are made of corrosion resistant materials that extend 2" minimum back from the roof edges and bend downward over them. Apply drip edge directly to the deck along the eaves and over the underlayment along the rakes. Note: Drip edge is required by most building codes.

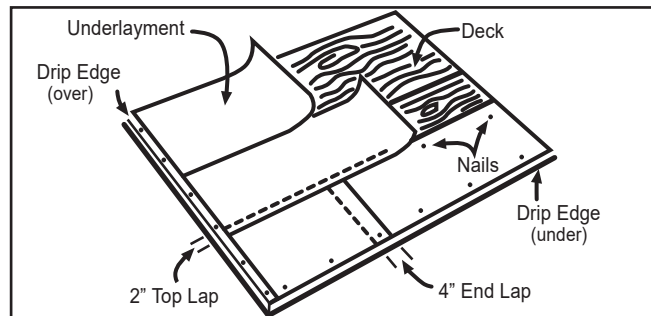

PABCO® Roofing Products
Exceptional People. Remarkable Products.®

1476 Thorne Road Tacoma, WA 98421
253.272.0374 www.pabcoroofing.com

4 Eaves Flashing

If winter temperatures average 30 °F or less, and ice may form along eaves to cause a back-up of water, install an eave flashing for ice dam protection. Install a self adhering, peel and stick type underlayment sheet complying with ASTM D1970 parallel to the eaves, applied per the manufacturer's instructions. This sheet extends 1/4" to 3/8" beyond the drip edge at the eaves. This sheet extends up the roof to at least 24" inside the interior wall line. Horizontal laps (when needed), are located outside the wall line.

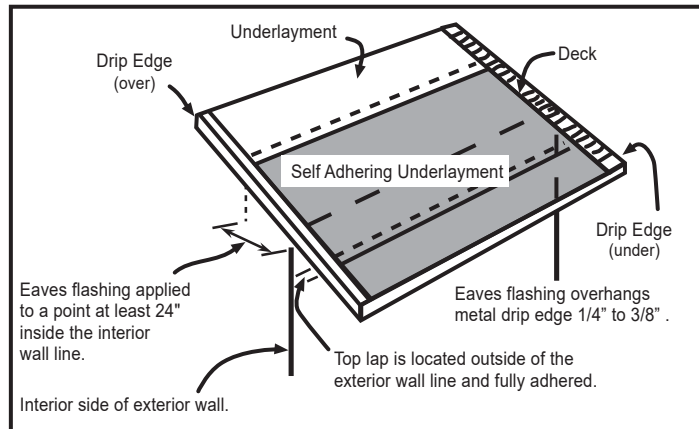

5 Nailing Instructions

PABCO® recommends the use of nails. Most building codes do not allow the use of staples. Use five nails per shingle for normal application, positioned in the nail zone as shown below. The nail zone is a band of light colored granules running across the face of the shingle 9-1/2" to 11" up from the leading edge of the teeth. Nails must be at least 1" long, aluminum or galvanized, 3/8" head, 11 or 12 gauge roofing nails. Drive nails flush with shingle surface. **NAILS MUST NOT BE OVER DRIVEN.** See Section 8 for six nail application location and use. See our Paramount® Nailing Instructions for additional details.

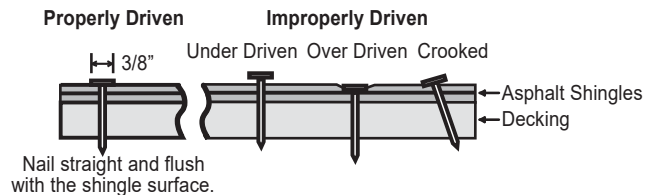
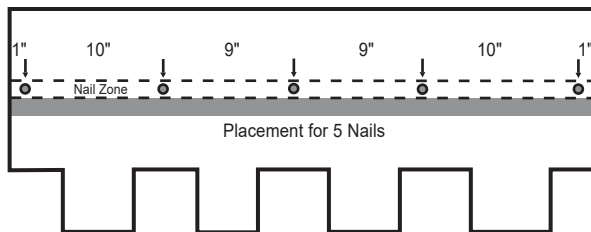

6 Valleys

Valley application must comply with the building code. Where allowed, PABCO® recommends using open metal valleys (closed cut valleys are also accepted). This valley starts with a 36" underlayment centered down the valley. PABCO® recommends self adhering underlayment (ASTM D1970) for this bottom layer. The underlayment felt covering the decks is trimmed to overlap this at least 6". Apply a second layer of underlayment felt over this, centered down the valley. The metal valley flashing must be at least 26 gauge galvanized metal or an equally corrosion resistant metal, at least 24" wide. It is formed with a "W" shape and center rib. Apply the metal valley without puncturing it. Center the metal in the valley over the second layer of underlayment, extending beyond the eaves drip edge 1/4" to 3/8". If more than one piece of flashing metal is needed, the lower piece is nailed at the top. The upper piece laps over the lower piece nails by at least 8" and the lap is cemented together with asphalt roof cement complying with ASTM D4586. Snap 2 chalk lines down the valley, starting 2" on either side of the valley center line at the top of the valley and diverging 1/8" from each other per foot down the valley. Apply the shingles into the valley in the normal sequence of application for the rest of the roof. Trim the shingles to the chalk line, but never use a piece less than 12" wide. If necessary, trim the preceding shingle on the course. Apply the shingles into the valley so that no nails pass through the valley metal. Clip the upper shingle corner (in the valley) 1" at 45°. Embed each shingle in a 3" wide strip of asphalt roof cement. See our Paramount® Valley Application for additional details and alternatives.

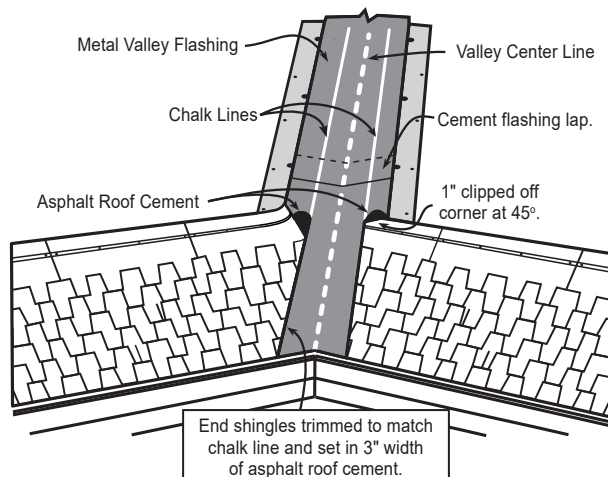

7 Application, 5-5/8" Diagonal Offset Pattern

FIRST STARTER COURSE: Use PABCO® Universal Starter or a self sealing three tab shingle with the tabs cut off. Remove 7-1/2" from the end of the first piece and apply it at the lower left hand corner of the roof, with the adhesive at the eaves, overhanging the drip edge 1/4" to 3/8". Nail in place with 4 nails about 2" up from the eaves, spaced evenly across the shingle. Continue the Universal Starter across the deck with full shingles.

SECOND STARTER COURSE: Use Paramount® Starter to assure matching colors. Cut 5-3/4" off the length of the first slab of Paramount Starter and apply at the lower left hand corner of the roof. This Starter is applied flush with the first starter course at the rake and eaves. Continue the Starter across the deck with full shingles.

FIRST COURSE: Start with a full Paramount® shingle aligned with the edges of the Paramount® Starter at the lower left hand corner of the roof.

SECOND COURSE: Cut 5-3/4" from the left end of a shingle and apply the 34-1/4" long piece over the headlap of the first course shingle, exposing the first course 4-1/2".

THIRD COURSE: Cut 11-1/2" from the left end of the shingle and apply the 28-1/2" long piece over the headlap of the second course shingle, exposing the second course 4-1/2".

SUCCEEDING COURSES: Start courses four through seven with a partial shingle 5-3/4" shorter progressively, establishing the overall diagonal offset pattern. See illustration below. (Pieces cut from shingles along the left rake can be used to finish off courses at the right rake.) Now apply full shingles to courses one through seven. Repeat the diagonal pattern from the first seven courses by starting course eight as a full shingle and proceeding with partial shingles 5-3/4" shorter progressively each time.

See our Paramount Getting Started document for additional details.

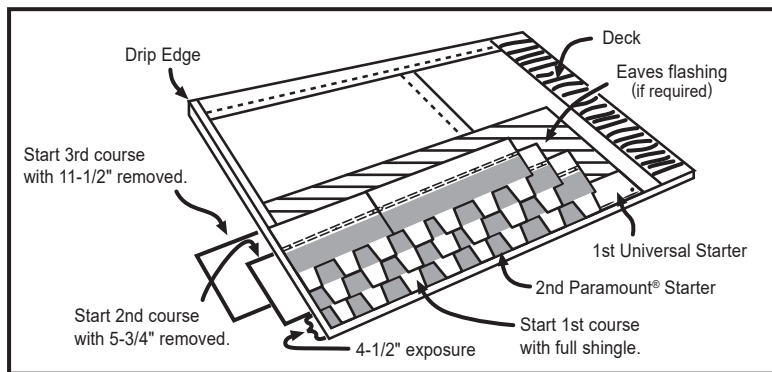

8 Special Applications

For areas where local knowledge indicates exposure to high winds may occur or where required by code, shingles must be applied with 6 nails (spaced as shown below) and sealed to qualify for wind damage warranty coverage.

Steep Slope Application: On slopes greater than 21" per foot (Mansard type roofs), 6 nails are required, spaced as shown below. These shingles must be hand sealed at the time of application with asphalt roof cement complying with ASTM D4586 Type II, applying 4 spots about the size of a quarter, each horizontally centered behind and about 1" up from the bottom edge of the covering tooth.

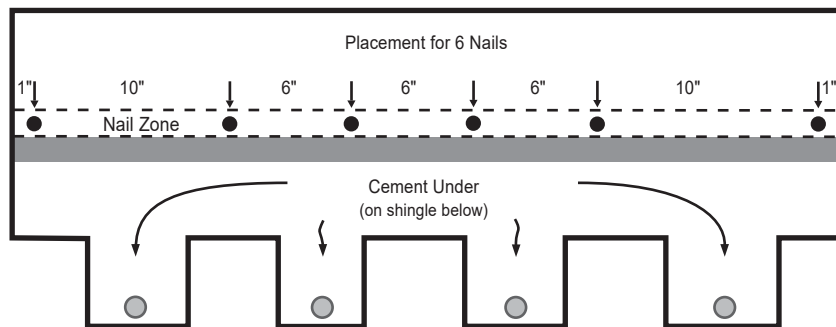

Low Slope Application: On slopes between 2" and 4" per foot, where allowed by code, apply one layer of a self-adhering ASTM D1970 sheet per the manufacturer's instructions. As an alternative, provide a double layer of breathable underlayment, asphalt saturated felt underlayment complying with ASTM D226, D4869, or D6757, or equivalent and the building code. For 36" asphalt saturated felts, start by applying a minimum 19" wide underlayment strip across the eaves. Over this, apply the full 36" wide sheet. Continue 36" wide sheets, lapping each 19" over the preceding course. For other sheets, follow the low slope instructions for that material.

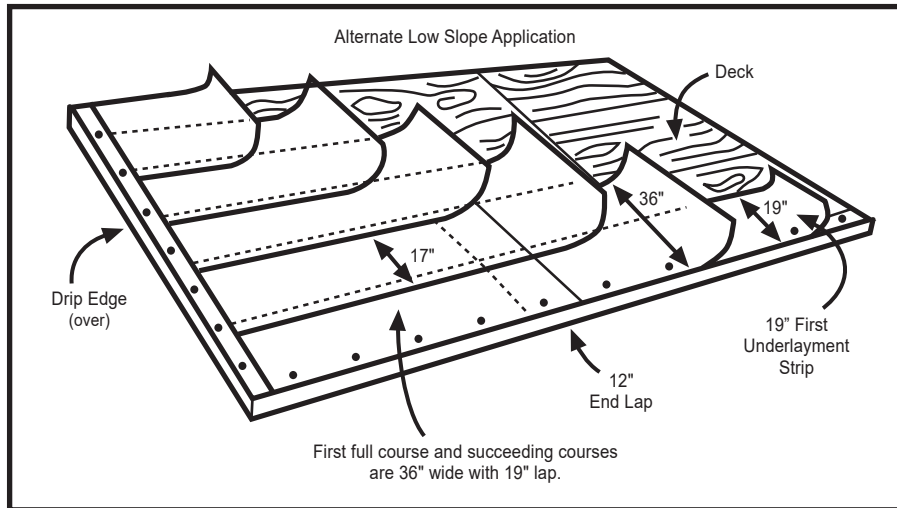

9 Base Flashing

The base flashing for the front of the chimney is installed as illustrated over the headlap of the last course of shingles below the chimney, and extending up the chimney. Set the roof and chimney overlaps in asphalt roof cement. Where shingle ends are against a vertical surface (sidewall or chimney), the shingles must be flashed with metal step flashing shingles applied over the end of each shingle. The flashing shingles are at least 8" by 11", bent to extend 4" out over the shingles on the roof deck and 4" up the vertical surface, and extending up the roof 11". Each flashing shingle is placed so that its leading (bottom) edge is just back from the exposed edge of the shingle which will overlap it. It is secured to the deck with one nail near the top corner. See ARMA *Residential Asphalt Roofing Manual* for additional details.

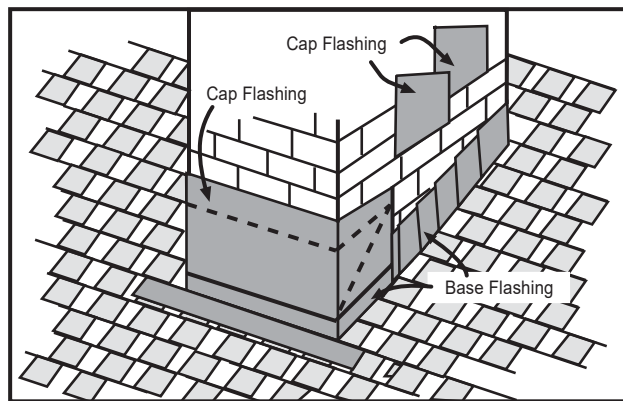

10 Cap (Counter) Flashing

The base flashing of chimneys, skylights, vents, and adjoining walls must be covered by a metal cap flashing. The cap flashing extends at least 1" into the masonry mortar joints and is caulked with asphalt roof cement to insure a water-tight connection. The base flashing is cut to cover the cricket and extend 6" up the brickwork on the chimney.

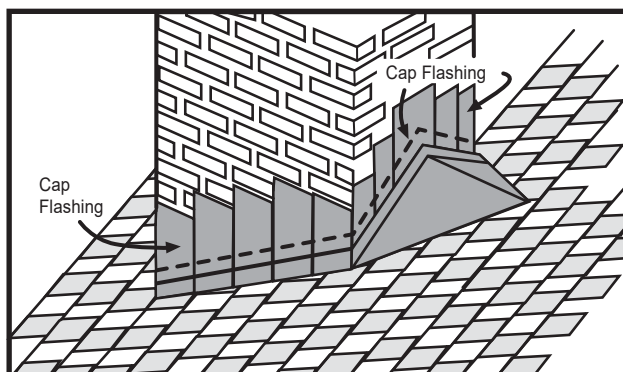

11 Hips and Ridges

Trim shingles even with the ridge and cover with PABCO® Shadow Cap shingles exposed 5-5/8" to the weather. Nail each side 6-5/8" back from the exposed end (just behind shadow line) and 1" up from the bottom edge with galvanized roofing nails long enough to penetrate into the deck 3/4", or through if the deck is less than 3/4". Applying PABCO® Shadow Cap double thick is recommended to accent the hip & ridge lines. **IMPORTANT:** In cold weather (40 °F or below) store shingles for hip & ridge in heated location 24 hours prior to application to assist in bending the shingles without damaging or cracking them.

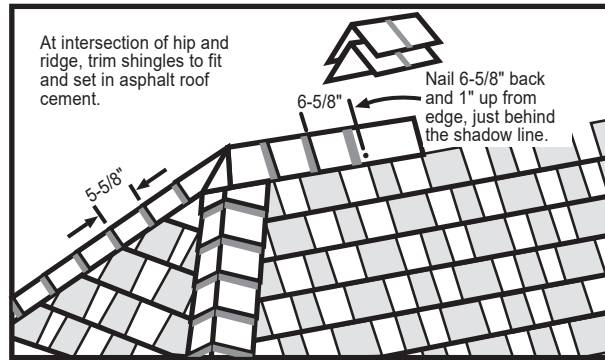

12 Reroofing

When reroofing, confirm the ventilation complies with the requirements in Section 1 and the deck complies with the requirements detailed in Section 2. PABCO® recommends that this shingle not be used for covering over an existing shingle roof. Remove all roofing materials from the deck. Inspect and repair the deck as needed. Proceed with the application as with a new roof.

The PABCO® Limited Shingle Warranty

PABCO warrants that our shingles are free from manufacturing defects that adversely affect their performance. PABCO is not responsible for failures of any roof system that are not directly attributable to a PABCO product. See the PABCO Limited Shingle Warranty for details, limits, and conditions.



1476 Thorne Road Tacoma, WA 98421
253.272.0374 www.pabcoroofing.com